

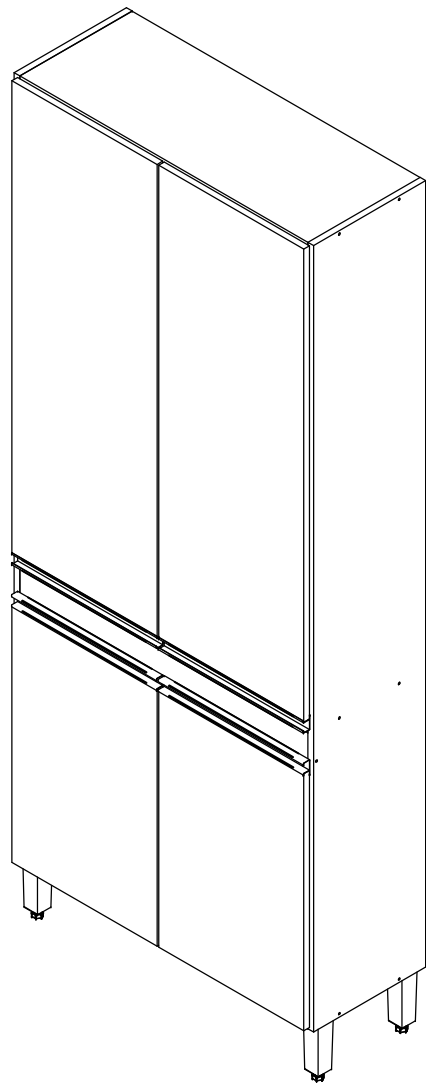







Panelheiro Duplo 0452

Instruções de Montagem Assembly Instructions / Instrucciones de Montaje

01

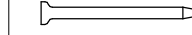
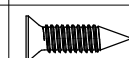

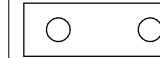
**Lista de ferragens
Hardware list
Lista de materiales**

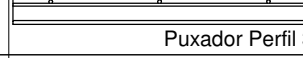
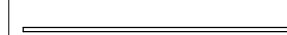
REF		QNT
A	 Cavilha 6 x 30	08
B	 Parafuso chato 3,5 x 40	14
C	 Parafuso flange 5 x 50	04
D	 Parafuso chato 4x25	04
E	 Prego 10 x 10	40
F	 Parafuso chato 3,5x14	52
G	 Suporte Prateleira 6x8	16
H	 Dobradiça	10
I	 Adesivo Tapa Furo	18
J	 Pé	04
K	 Puxador Perfil 388mm	04
L	 Perfil	01

Lista de peças / Parts lists / Lista de piezas

Nº	Descrição	Quant.
01	Lateral Esquerda	1
02	Lateral Direita	1
03	Tampo	2
04	Base	1
05	Porta Inferior	2
06	Porta Superior	2
07	Prateleira	4
08	Costa	2
09	Travessa	1

Ferramentas Necessárias

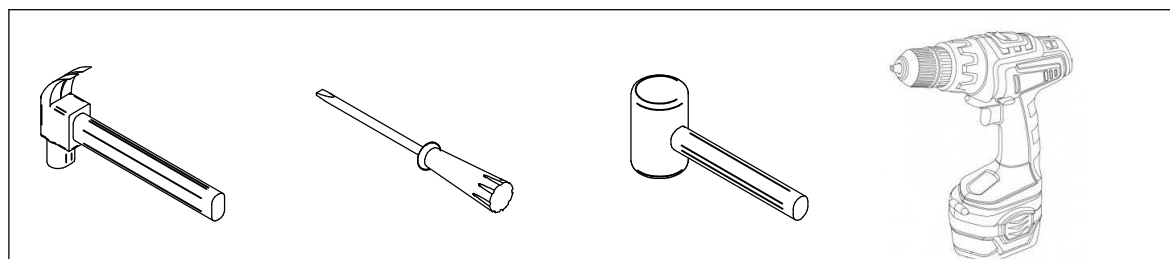

Antes de montar seu móvel, leia cuidadosamente o Manual de Instruções e o mantenha para futuras consultas. OBRIGADO.

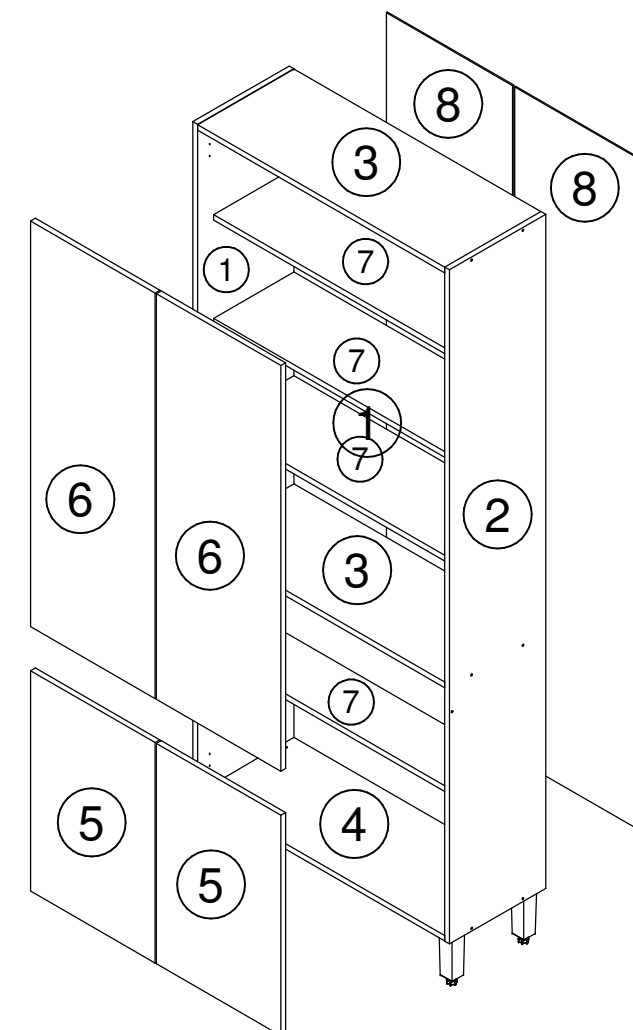

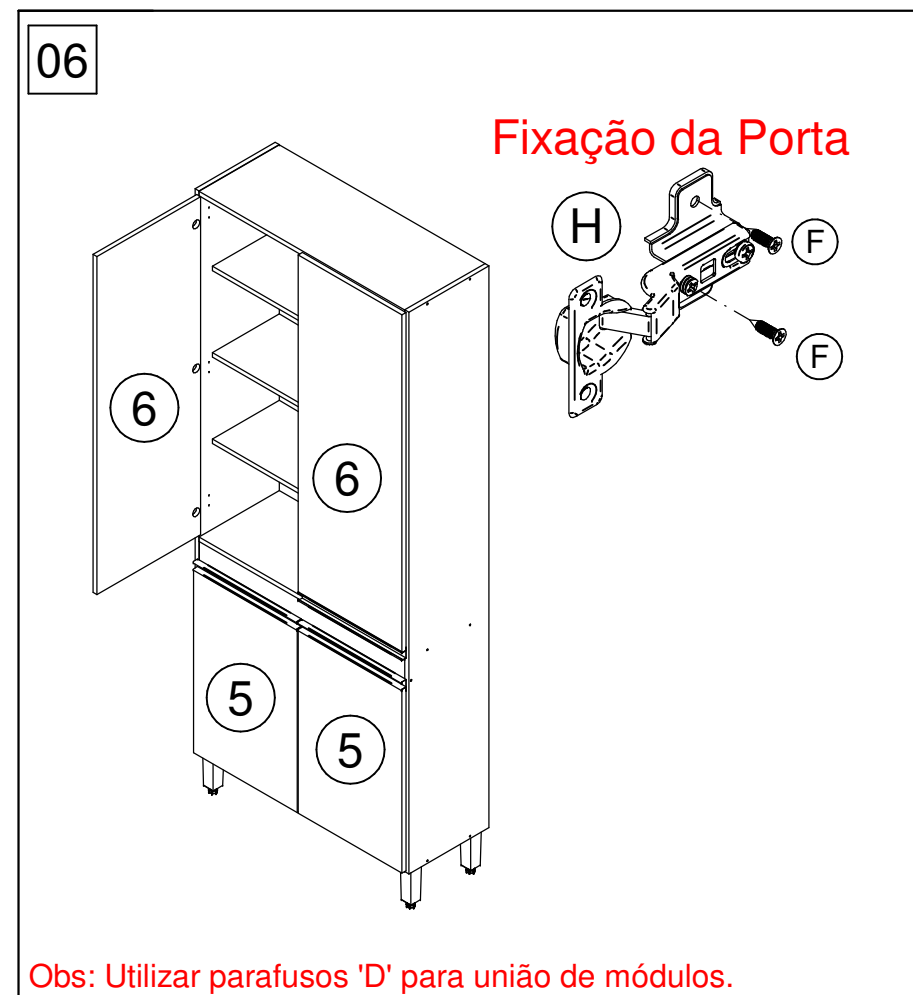
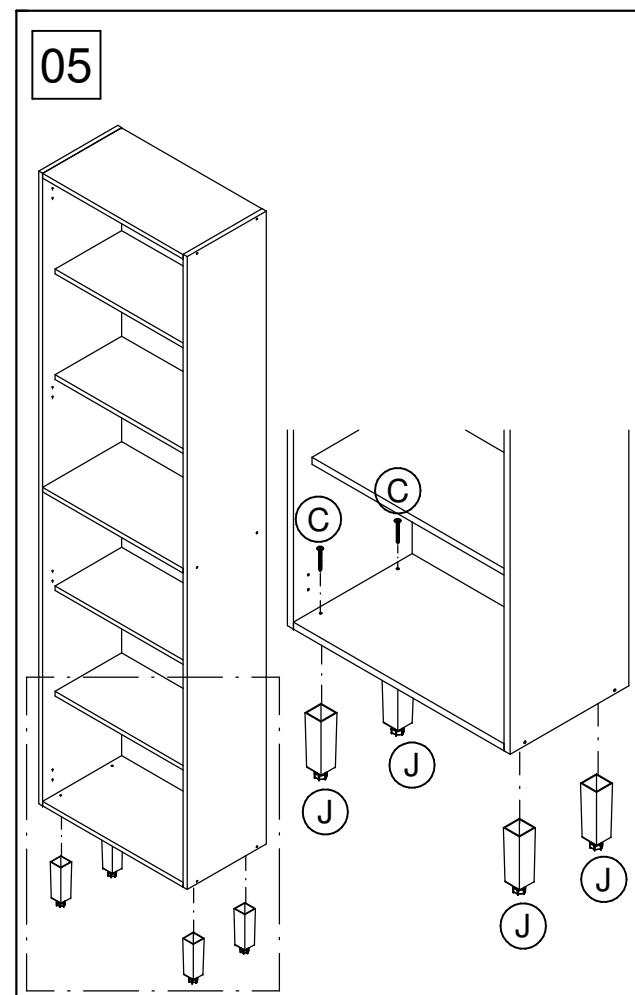
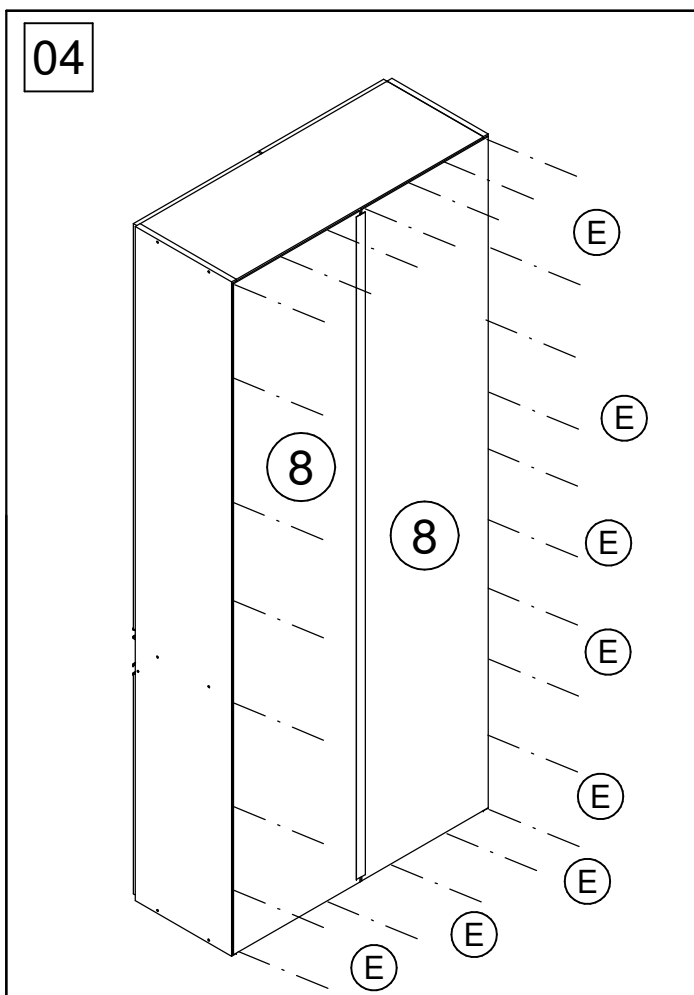
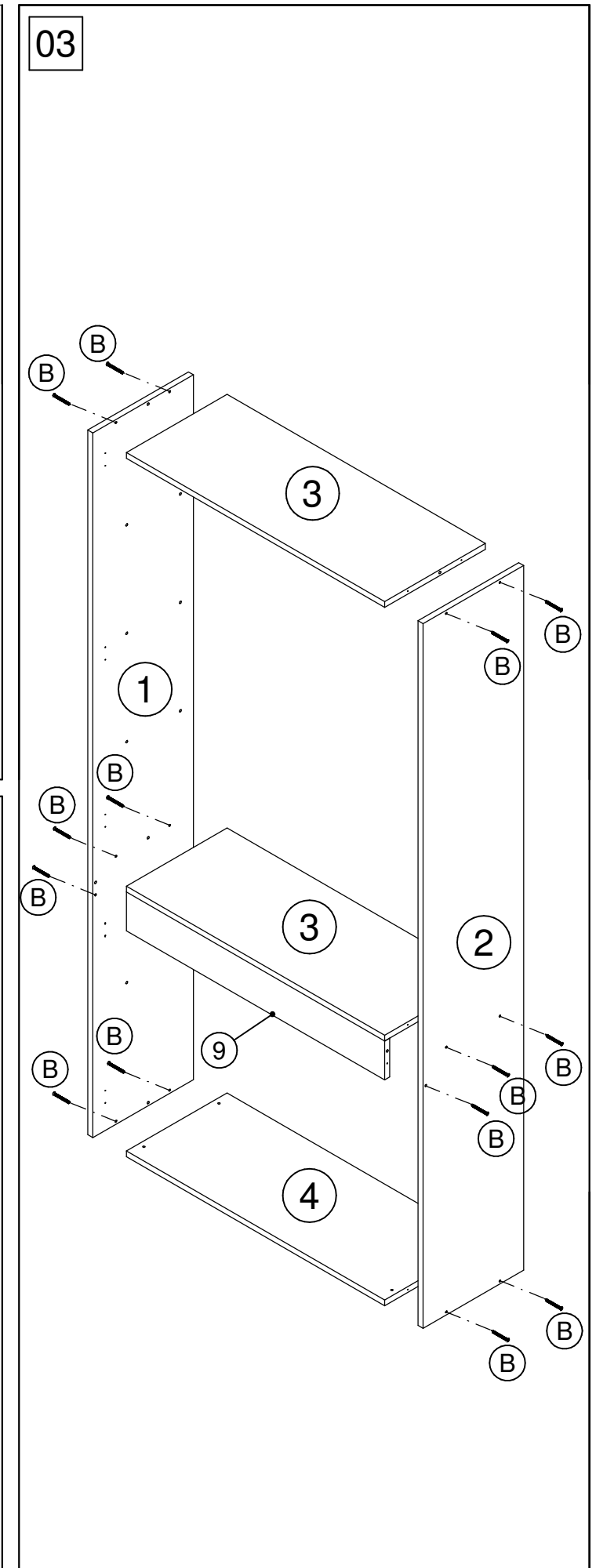
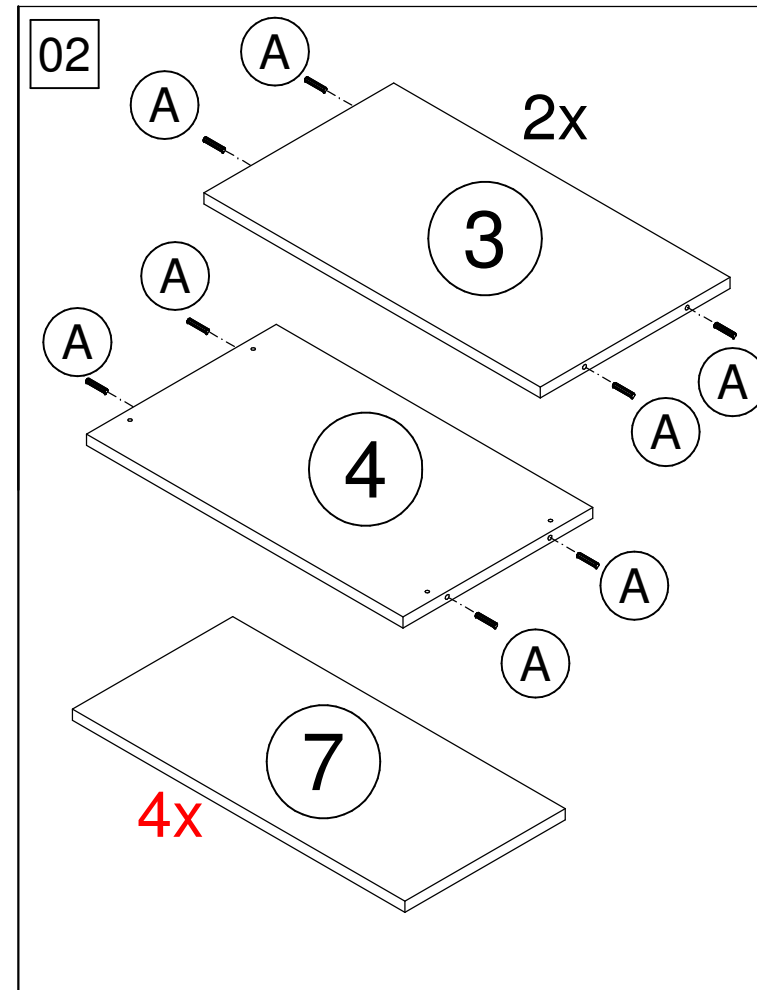
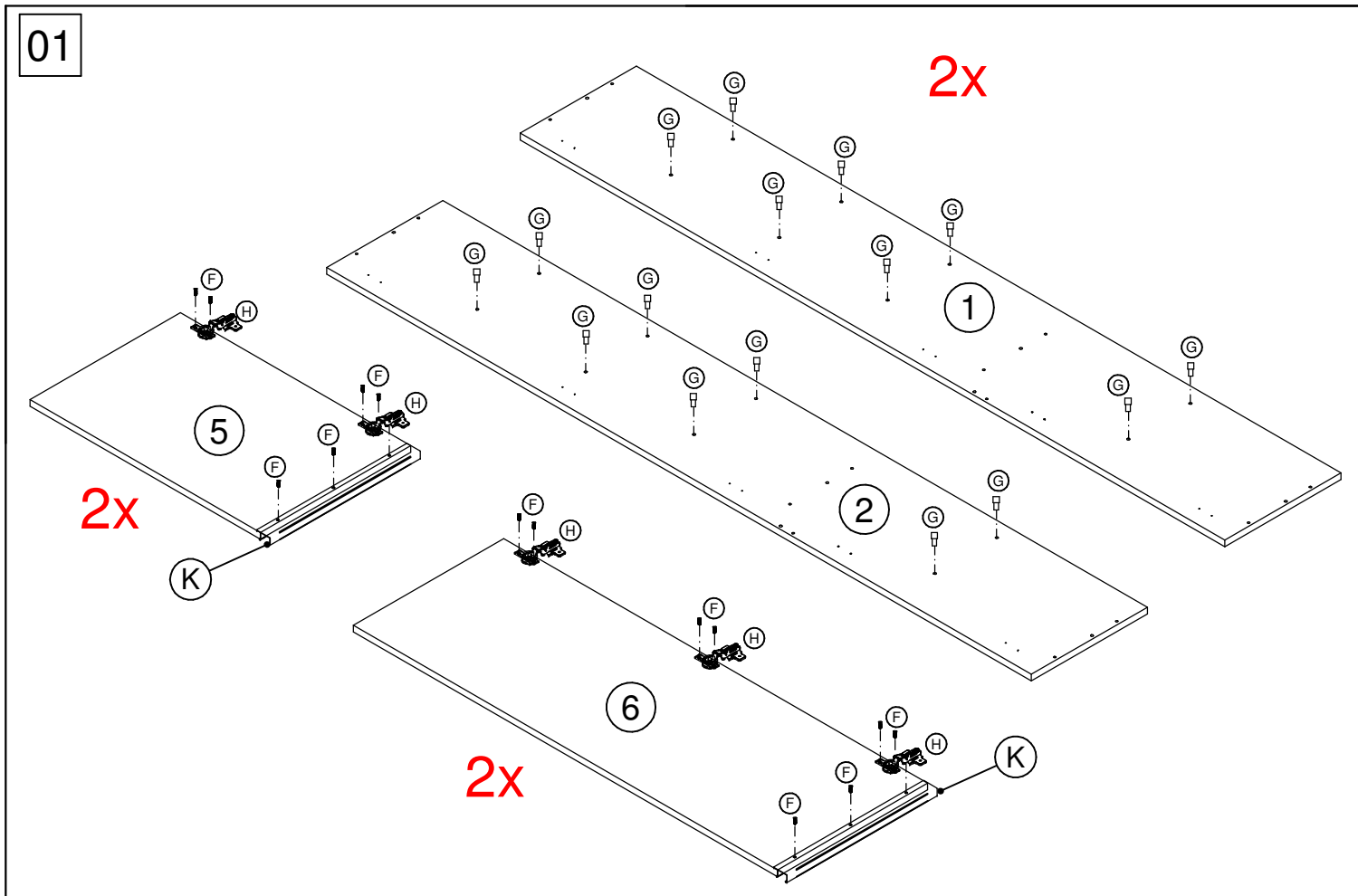

Obs: Utilizar parafusos 'D' para união de módulos.